

Quick Start Manual

 IO-Link



Safety Information



Warning | Caution | Danger

Indicates a potential hazard. Failure to follow all warnings may lead to equipment damage, injury, or death



Do Not Use Tools

Use of tool(s) may damage product beyond repair and potentially void product warranty.



Note | Technical Notes

Highlights additional information or detailed procedure.



WARNING!



Do Not Remove Under Pressure

Failure to follow these instructions may result in the sensor being ejected from the pipe!

If leaking is observed from the retaining cap, it indicates defective or worn o-rings on the sensor. Do not attempt to correct by further tightening.

- ⊙ De-pressurize and vent system prior to installation or removal
- ⊙ Confirm chemical compatibility before use
- ⊙ DO NOT exceed maximum temperature or pressure specifications
- ⊙ ALWAYS wear safety goggles or face-shield during installation and/or service
- ⊙ DO NOT alter product construction



Please ensure that the Instruments are not to be subject to water hammer or pressure spikes! Always Pressure Test System with H₂O Prior to Initial Start-Up

Before installation be certain the appropriate instrument has been selected considering operating pressure, full scale pressure, wetted material requirements, media compatibility, operating temperature, vibration, pulsation, desired accuracy and any other instrument component related to the service application including the potential need for protective attachments and/or special installation requirements. Failure to do so could result in equipment damage, failure and/or personal injury. Ensure only qualified personnel are permitted to install and maintain this instrument.



Pressurize System Warning

Sensor may be under pressure, take caution to vent system prior to installation or removal. Failure to do so may result in equipment damage and/or serious injury



Personal Protective Equipment (PPE)

Always utilize the most appropriate PPE during installation and service of Truflor products.



Please Ensure Full Pipe

ProPulse2® Series can be installed in a horizontal or vertical direction. Please ensure enough length of straight pipe to avoid turbulence that can effect readings.

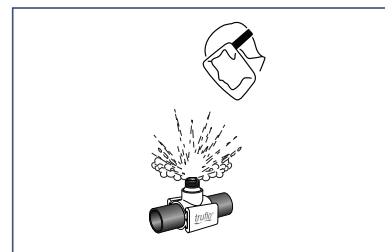

Truflo® — ProPulse® 2 Series

Mini Turbine Flow Meter

Product Description

The **ProPulse®2 Series** provides superior performance and delivers accurate ultra-low flow measurement that is highly repeatable under the most demanding of industrial environments.

The **ProPulse®2 Series** operates using a PP/PVDF rotor with encapsulated magnetic inserts, which rotate on a long-wearing set of zirconium ceramic bearings & rotor designed to provide years of reliability. As the rotor spins, the magnetic field produced by the magnets is picked up via a Hall Effect Sensor, which converts the rotation into a square wave NPN pulse, 4 – 20mA, IO-Link or RS485 output that can be sent directly to a metering pump, local display or PLC

Typical Application

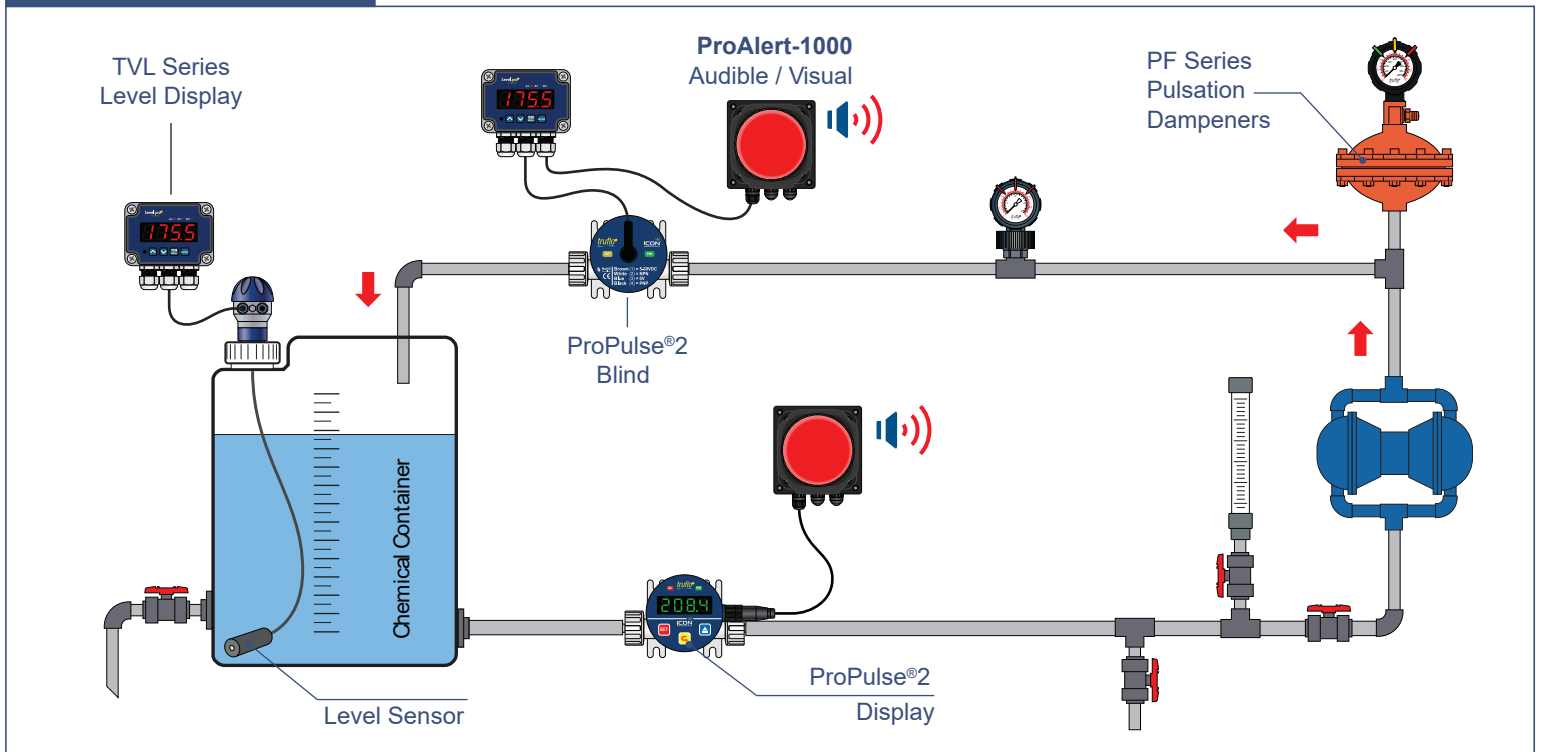

Model Selection

PP - M - 03H - PP

Output Option	Tube Type		Material
W : Blind with NPN Pulse 4-20mA	02N : 1/8" NPT	06T : 3/8" Straight Tube	PP : PP
N : Blind with NPN PNP	03H : 3/16" Hose Barb	06H : 3/8" Hose Barb	PF : PVDF
M : LED Display with 4-20mA NPN	04T : 1/4" Straight Tube	06F : 3/8" Flared	PA : PFA
R : LED Display with RS485	04F : 1/4" Flared		
P : LED Display with NPN PNP			

Technical Specifications

General	
Body Material	PP PVDF
O-Ring	FPM
Environmental Conditions	-4°F – 176°F -20°C – 80°C (35% – 85% RH)
Operating Temperature	PP : -4°F – 203°F -20°C – 95°C PVDF : -40°F – 250°F -40°C – 120°C
Max. Working Pressure Non-Shock	PP : 142 psi 10 bar PVDF : 217 psi 15 bar
Accuracy	± 1.0% of F.S. @ 25°C (PPW) ± 0.5% of F.S. @ 25°C (PPM & PPR)
Output Current	PPW (Blind) 50mA max PPM & PPR (Display) 150mA max
Operating Voltage	5 – 30VDC (Blind) 10-30VDC (Display)
Protection Class	NEMA 4X IP65
Display	4 Digits : 0.0 – 9999 (PPM PPR)

Wiring

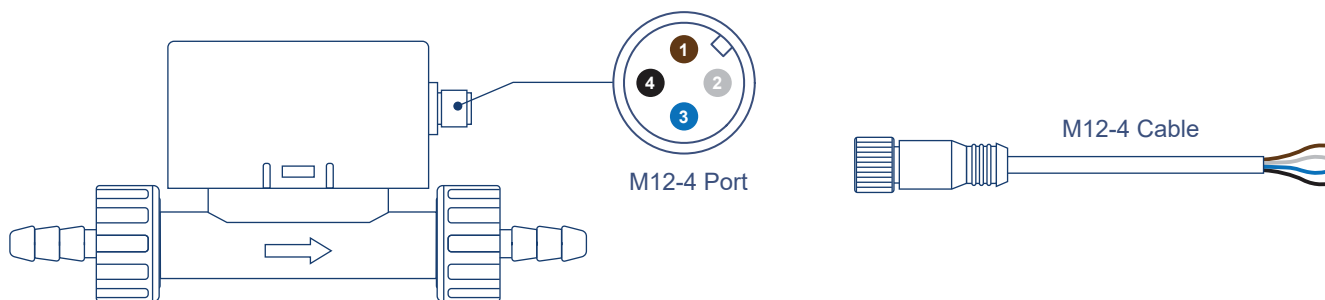

PPW- Blind (Pulse)		
Pin	Color	Function
1	Brown	+5-30VDC
2	White	NPN Output
3	Blue	-VDC
4	Black	PNP Output

PPR - Display (RS485)		
Pin	Color	Function
1	Brown	+10-30VDC
2	White	RS+
3	Blue	-VDC
4	Black	RS-

PPM - Display (Pulse + 4-20mA)		
Pin	Color	Function
1	Brown	+10-30VDC
2	White	NPN Output
3	Blue	-VDC
4	Black	+mA Output

Exploded View

1. M12 Quick Connection
2. Controller
3. Body
4. Turbine
5. True Union Design
6. Integral Mounting Platform

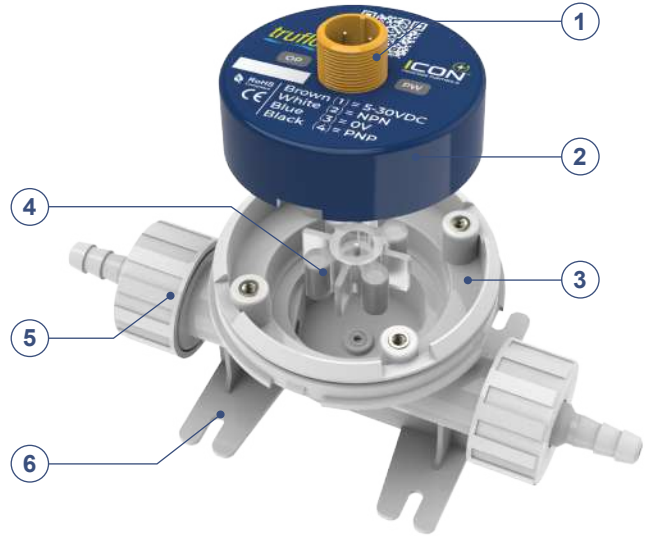



Display Functions



Setting Method

In Setting Status : The Settable Digit is Flicker

- | | |
|--|--|
|  | Key : To Change the Numerical Value |
|  | Key : To Shift the Digit |
|  | Key : To Enter into Setting Status or Load the Setting Value |

Programming

Steps	Display	Range	Description
#1 Main Display Press SET + ↺ HOLD 3 SEC		0 ~ 9999	Current Value
#2 Setting of Lock Press SET Key		0 ~ 99	Lk = 10 : Settable
#3 Decimal Point Selection Press SET Key		0 ~ 3	dP.0 = Flow rate meter 0 ~ 9999 dP.1 = Flow rate meter 0.0 ~ 999.9 dP.2 = Flow rate meter 0.00 ~ 99.99 dP.3 = Flow rate meter 0.000 ~ 9.999
#4 Unit Selection Press SET Key		L / KL / G / C	ut.L = LPM ut.KL = KLPM ut.G = GPM ut.C = cc/M
#5 Alarm Mode Setting Press SET Key		0 ~ 4	Range : ALt.0 ~ ALt.4 *Refer to the Mode of Alarm
#6 Power on Delay Time Press SET Key		0 ~ 99 s	t.00 = Delay time of Alarm Output (sec)

Mode of Alarm

ALt No.	Description
ALt = 0	Non alarm
ALt = 1	$PV \geq AL \rightarrow$ Alarm ON ; $PV < SV - Hys \rightarrow$ Alarm OFF
ALt = 2	$PV \leq AL \rightarrow$ Alarm ON ; $PV > SV + Hys \rightarrow$ Alarm OFF
ALt = 3	$AL + Hys \geq PV \geq AL - Hys \rightarrow$ Alarm ON ; $PV > AL + Hys$ or $PV < SV - Hys \rightarrow$ Alarm OFF
ALt = 4	$AL + Hys \geq PV \geq AL - Hys \rightarrow$ Alarm OFF ; $PV > AL + Hys$ or $PV < SV - Hys \rightarrow$ Alarm ON

K Factor | Alarm Programming

Steps	Display	Range	Description
#1 Main Display Press SET HOLD 3 SEC		0~9999	Current Value
#2 K Factor Status Press SET Key		K.0 or K.1	Coefficient for Flow rate meter K.0 = 0 ~ 9999; K.1 = 10000 ~ 19999
#3 K Factor Setting Press SET Key		0 ~ 9999 or 10000 ~ 19999	K.0 Setting Range = 0 ~ 9999 K.1 Setting Range = 10000 ~ 19999
#4 Alarm Setting Status Press SET Key			Alarm Set Point
#5 Alarm Value Setting Press SET Key		0~9999	Enter Value
#6 Alarm Hysteresis Setting Status Press SET Key			Alarm Hysteresis
#7 Alarm Hysteresis Setting Press SET Key		0~9999	Enter Value Prevents Relay Chatter

Transmitter Range Setting (4-20mA Output Models)

Note: Set Lck.19 in Lock Settings (Refer Pg. 6)

Steps	Display	Range	Description
Main Display Press ESC HOLD 3 SEC		0~9999	Current Value
Transmitter Range Press SET Key			20mA (High) Range
20mA Value Press SET Key		0~9999	Set 20mA - Max. Flow Rate

Setting of RS485 Communication (For RS485 Output Models)

Steps	Display	Range	Description
#1 Main Display Press SET + ▲ HOLD 3 SEC			Current Value
#2 Id NO Press SET Key		1~255	
#3 Protocol Press SET Key		0 or 1	rs=0 : Modbus-RTU rs=1 : Modbus-ASCII
#4 BPS Press SET Key		0 ~ 2	bPS.0 : 9600 bps bPS.1 : 19200 bps bPS.2 : 38400 bps
#5 Configuration Press SET Key		0 ~ 5	1. blt.0 = 8N1 : 8 bit non parity; 2. blt.1 = 8O1 : 8 bit odd parity 3. blt.2 = 8E1 : 8 bit even parity; 4. blt.3 = 8N2 : 8 bit non parity 5. blt.4 = 7O1 : 7 bit odd parity; 6. blt.5 = 7E1 : 7 bit even parity

Parameter Address

Address	Parameter	Description	Address	Parameter	Description	Address	Parameter	Description
00H 01H	CV	Flow Rate Value	00H 05H	HYS	Alarm Hysteresis Setting	00H 09H	ALt	Alarm Mode Setting
00H 02H	K.0	K Factor Range Selection	00H 06H	Lk	Setting of Lock	00H 0AH	t	Alarm Delay Time
00H 03H	K	K Factor	00H 07H	dP	Decimal Point Selecting	00H 0BH		Output status*
00H 04H	AL	Alarm Value Setting	00H 08H	U t	Unit Selecting	00H 0CH		

Output Status*

Data	Alarm	Data	Alarm
00H 00H	Off	00H 01H	On

Truflo® — ProPulse® 2 Series

Mini Turbine Flow Meter

Flow Range

Connection	Flow Range (LPM)	Flow Range (GPM)	K Factor *(LPM/GPM)
02N 1/8" NPT	0.12 ~ 16.20	0.032 ~ 4.280	5350
03H 3/16" Hose Barb	0.04 ~ 2.20	0.010 ~ 0.581	5350
04T 1/4" Straight Tube	0.12 ~ 8.20	0.032 ~ 2.166	1700
04F 1/4" Flared	0.40 ~ 2.80	0.106 ~ 0.740	1700
06T 3/8" Straight Tube	0.12 ~ 16.20	0.032 ~ 4.280	875
06H 3/8" Hose Barb	0.12 ~ 16.20	0.032 ~ 4.280	875
06F 3/8" Flared	0.40 ~ 9.80	0.106 ~ 2.589	875

* Note : K factor can be modified to fit specific application

Dimensions (mm)

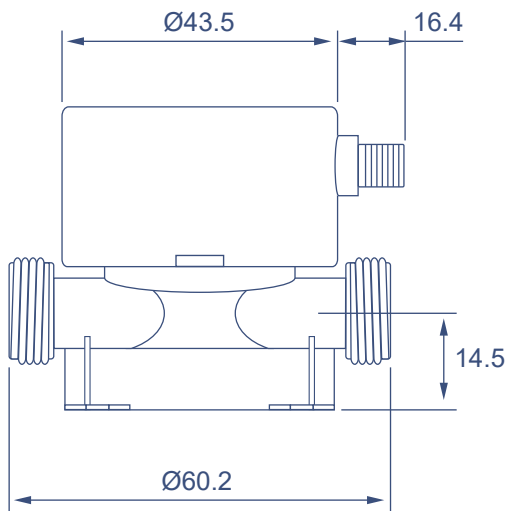
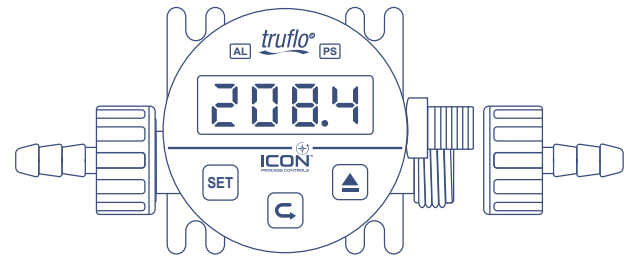
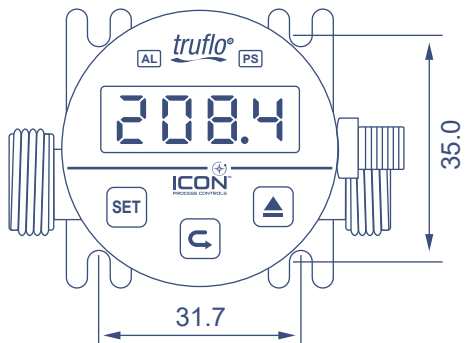

Hose Barb : 03H

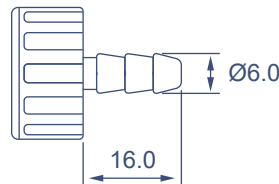

Hose Barb : 06H

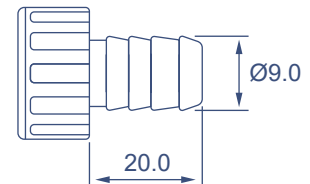

Straight Tube : 04T

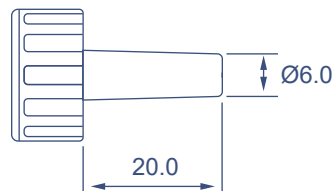

Straight Tube : 06T

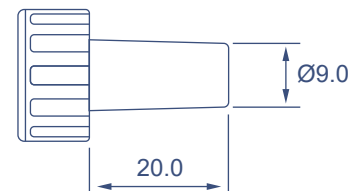

Installation Positions

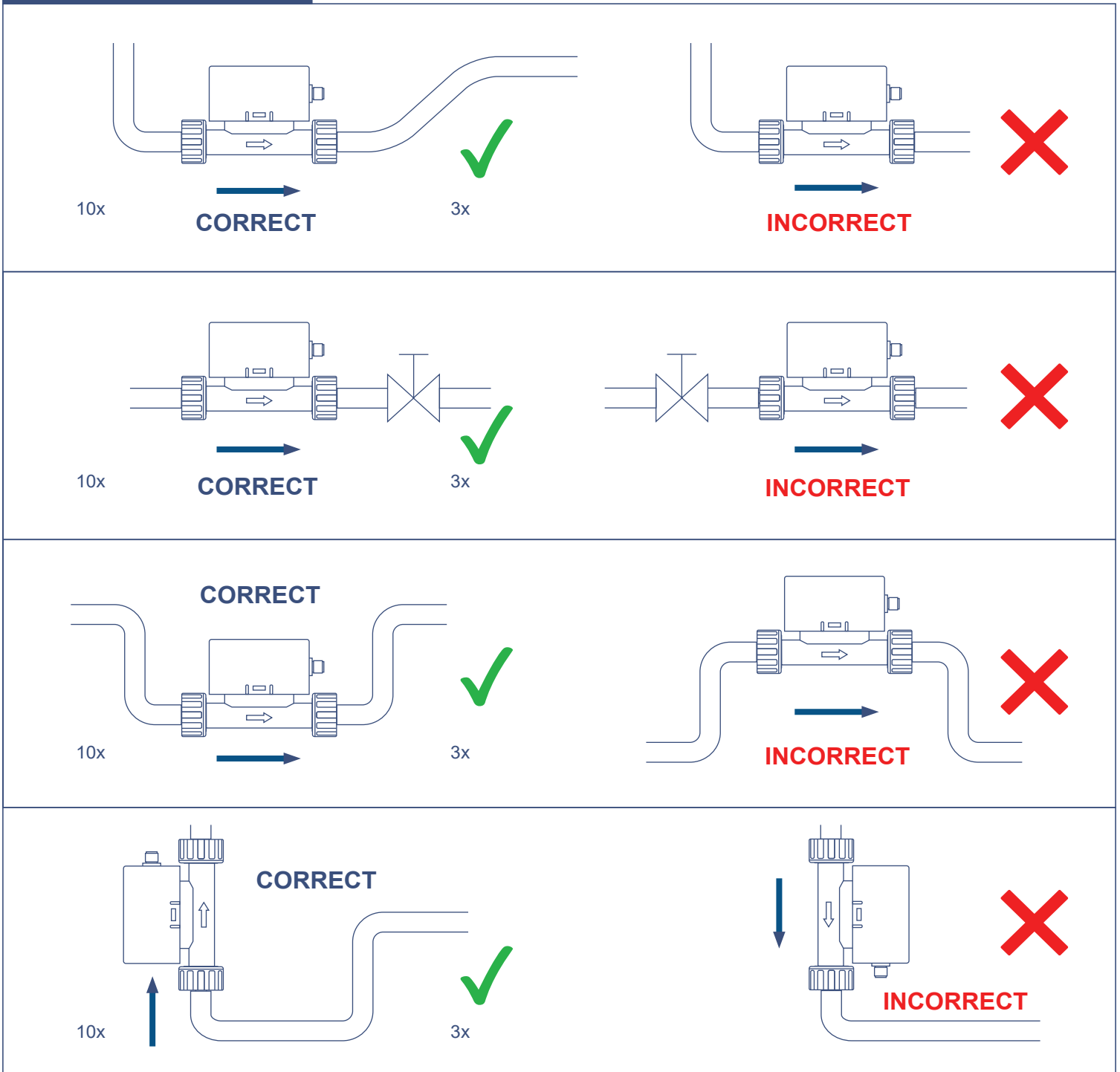

1. Please make sure the measuring tube must be filled with the fluid under normal operation.
2. **ProPulse2® Series** can be installed at horizontal or vertical direction.
3. Please set enough length of straight pipe to avoid the vortex might be existed.
(The minimum straight upstream must be over 10 x DN and downstream must be observed over 3 x DN)
4. Please adopt filtering device in the upstream to avoid the paddle wheel from be damaged by the solids or fibers.
5. Please do not flush the pipe after the measuring unit being installed, if do that may crack the ceramic shaft.

Warranty, Returns & Limitations

Warranty

Icon Process Controls Ltd warrants to the original purchaser of its products that such products will be free from defects in material and workmanship under normal use and service in accordance with instructions furnished by Icon Process Controls Ltd for a period of one year from the date of sale of such products. **Icon Process Controls Ltd** obligation under this warranty is solely and exclusively limited to the repair or replacement, at **Icon Process Controls Ltd** option, of the products or components, which **Icon Process Controls Ltd** examination determines to its satisfaction to be defective in material or workmanship within the warranty period. Icon Process Controls Ltd must be notified pursuant to the instructions below of any claim under this warranty within thirty (30) days of any claimed lack of conformity of the product. Any product repaired under this warranty will be warranted only for the remainder of the original warranty period. Any product provided as a replacement under this warranty will be warranted for the one year from the date of replacement.

Returns

Products cannot be returned to **Icon Process Controls** without Icon's prior authorization. To return a product that is thought to be defective please submit a customer return (MRA) request form and follow the instructions therein. All warranty and non-warranty product returns to **Icon Process Controls** must be shipped prepaid and insured. Icon will not be responsible for any products lost or damaged in shipment.

Limitations

This warranty does not apply to products which:

- 1) Are beyond the warranty period or are products for which the original purchaser does not follow the warranty procedures outlined above;
- 2) Have been subjected to electrical, mechanical or chemical damage due to improper, accidental or negligent use;
- 3) Have been modified or altered;
- 4) anyone other than service personnel authorized by **Icon Process Controls Ltd** have attempted to repair;
- 5) have been involved in accidents or natural disasters;
- 6) Are damaged during return shipment to **Icon Process Controls**.

Icon Process Controls reserves the right to unilaterally waive this warranty and dispose of any product returned to Icon where :

- 1) There is evidence of a potentially hazardous material present with the product;
- 2) The product has remained unclaimed at **Levelpro** for more than 30 days after **Icon Process Controls** has dutifully requested disposition.

This warranty contains the sole express warranty made by **Icon Process Controls Ltd** in connection with its products. **ALL IMPLIED WARRANTIES, INCLUDING WITHOUT LIMITATION, THE WARRANTIES OF MERCHANTABILITY AND FITNESS FOR A PARTICULAR PURPOSE, ARE EXPRESSLY DISCLAIMED.** The remedies of repair or replacement as stated above are the exclusive remedies for the breach of this warranty. **IN NO EVENT SHALL Icon Process Controls Ltd BE LIABLE FOR ANY INCIDENTAL OR CONSEQUENTIAL DAMAGES OF ANY KIND INCLUDING PERSONAL OR REAL PROPERTY OR FOR INJURY TO ANY PERSON. THIS WARRANTY CONSTITUTES THE FINAL, COMPLETE AND EXCLUSIVE STATEMENT OF WARRANTY TERMS AND NO PERSON IS AUTHORIZED TO MAKE ANY OTHER WARRANTIES OR REPRESENTATIONS ON BEHALF OF Icon Process Controls Ltd.** This warranty will be interpreted pursuant to the laws of the province of Ontario, Canada.

If any portion of this warranty is held to be invalid or unenforceable for any reason, such finding will not invalidate any other provision of this warranty

For additional product documentation and technical support visit www.iconprocon.com | e-mail: sales@iconprocon.com support@iconprocon.com | Ph: 905.469.9283



Corrosion-Free
Instrumentation Equipment